

# DEPTH COMPUTERIZED CALIPER

## USER MANUAL





Item No	Range		Resolution		Accuracy	Base	Waterproof	Indication	Data output	Calibration
	mm	inch	mm	inch	μm	mm			Wireless	ISO 17025
1432010157	0-150	0-6"	0,005	0.0002"	±20	102	IP54	computerized MICS system with 1,54" touchscreen	max 50 m	+
1432010207	0-200	0-8"	0,005	0.0002"	±20	102	IP54		max 50 m	+
1432010307	0-300	0-12"	0,005	0.0002"	±30	102	IP54		max 50 m	+

## TECHNICAL DATA

Parameters	
LED display	color 1,54 inch
Resolution	240x240
Indication system	MICS 3.0
Power supply	Rechargeable Li-Pol battery
Battery capacity	450-800 mAh (depends of device)
Charging port	micro-USB
Case material	Aluminium
Buttons	Switch (Multifunctional), Reset
Wireless data transfer	up to 50m on open area

Clean the oil from the measuring surfaces of caliper by cloth.  
For recharging caliper (Li-Pol rechargeable battery) connect it with standard USB cable to charger device.

**DO NOT LEAVE UNCHARGED CALIPER FOR A LONG TIME.  
THIS MAY RESULT TO INTERNAL BATTERY FAILURE!**

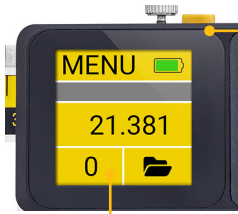

- SWITCH ON DEVICE** - button push (1 sec)
- SWITCH OFF DEVICE** - button push (3 sec)/ auto switch off
- DATA TRANSFER** - programming throw menu

**ZERO SETTING** - push 5 sec to ZERO setting

## CHARGING



**BUILT-IN BATTERY** - rechargeable Li-Pol battery



For charging connect USB cable

## BASE RECONNECTION

Sometimes, when battery was uncharges for a long time - necessary to make reading base reconnection



**PUSH ZERO button (5sec.) on main screen**



Activate WIRELESS data transfer in WIRELESS menu

Switch on Wireless data transmission  
Activating multifunctional button to save value to memory or send data by touchscreen or button push

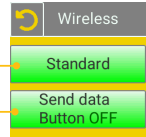

Connect instrument with MICS indication system to Tablet or PC  
Send data to Tablet or PC:

- by Touchscreen
- by Multifunctional button push (activated in Wireless menu)
- by Timer (activated in Timer menu)
- from Internal Memory

## MEMORY

For save measuring data to internal caliper's memory touch data area on screen or short button push. You can view saved data through menu or send Wireless connection to Windows PC, Android or iOS devices.

### Basic STATISTIC functions:

- MAX - maximum saved value
- MIN - minimum saved value
- AVG - average value
- D - variance VAR(x)

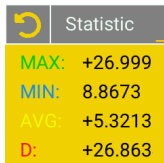

Saved values

Each value can be Deleted or Send to application

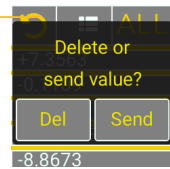

Button ALL select all values  
All values can be Deleted or Send to application

### MEMORY settings

Memory sub-menu

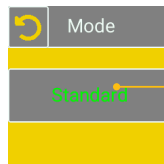

Selecting Standard mode or  
No saving data to internal memory



## WIRELESS CONNECTION



USB-DONGLE

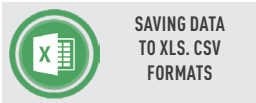
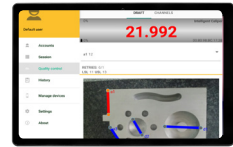
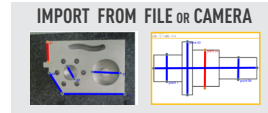

SAVING DATA TO XLS, CSV FORMATS



SAVING DATA TO XLS, CSV FORMATS



SAVING DATA TO XLS, CSV FORMATS



TRANSFER DATA TO CAD, SPC OR OTHER SOFTWARE



SAVING GRAPH



SAVING GRAPH



TRANSFER DATA TO EXCEL OR OTHER TABLE EDITORS



VOICE MODE



VOICE MODE

### DATA TRANSFER DISTANCE FOR INTELLIGENT INSTRUMENTS

- All MICROTECH Intelligent instruments has internal memory. You can collect data to memory and when it will be necessary transfer all data to the peripheral device with no data losing.
- It's possible transfer data, like in Wireless instruments up to 15 m or up 50 m with external antenna
- USB port can be used to transfer data directly to Windows PC



QUALITY CONTROL RESULTS



# MENU NAVIGATION



USE TOUCHSCREEN TO OPERATE MENU

MENU button **MENU** Battery Level

Colour can be changed according function **-0.0000** Actual value

Zero setting **0** Memory

## MEMORY WITH STATISTIC

ALL	Statistic
+7.3563	MAX: +26.999
-0.1109	MIN: 8.8673
+1.2293	AVG: +5.3213
+26.9993	D: +26.863
-8.8673	

## MENU CONFIGURATION



MAIN MENU



**LIMITS**  
color Go/NoGo

Max/Min

Enable

OK

**MAX/MIN**  
indicating max or min value

Formula

AX+BX+C

Set Aray

**FORMULA MODE**  
 $Ax^2+Bx+C$

Timer

+000 sec.

RESET



0.8970

0.8920

OK

RESET

**ERROR COMPENSATION**  
mathematical correction

Temp.comp.

Blank Check  
Solid always, Mo

+00.00

**TEMPERATURE COMPENSATION**  
manual correction

Resolution

X.0000

Millimeters

**RESOLUTION**  
selected up to 0.0001mm

Extra

Axis Mode  
Normal

CONNECT



Wireless

Standard

Send data  
Button OFF

**WIRELESS**  
modes of data transmission

Mode OFF

UART OFF

Keypad On

CONFIRM

**USB**  
USB connection configuration

Device

PIN

RESET

**DEVICE SETTING**  
pin, reset

Display

Angle 180

Sleep 0:05



Mode

Standard

**MEMORY SETTING**

Link to software

**SOFTWARE**  
link to download app

Calibration

DAY	MONTH	YEAR
01	01	2020

CHANGE

**CALIBRATION DATE**

MICROTECH

www.microtech.ua

COMP.CALIPER 1

FW: 3.0.5

MAC: 12345



## LIMITS GO/NOGO

<p><b>MENU SETTING</b></p> <p>← +000.000 → MAX value</p> <p>→ +000.000 → MIN value</p> <p>⌂ RANGE ↻ zero values</p>	<p><b>Colour indication limits</b></p> <p>MAX - NoGo more MAX value</p> <p>MIN - NoGo less MIN value</p> <p>RANGE - Go between MIN &amp; MAX</p> <p>NONE - disactivating mode</p>	<p><b>MAIN SCREEN INDICATION</b></p> <p>MENU </p> <p>-10.005</p> <p>0 </p> <p><b>NoGo</b></p> <p>MENU </p> <p>+8.0608</p> <p>0 mm</p> <p><b>Go</b></p>
---	---	--

## MAX/MIN

<p><b>MENU SETTING</b></p> <p>⌂ Max/Min</p> <p>Enable</p> <p>MAX</p>	<p><b>Indication and saving MAX or MIN values</b></p> <p>ENABLE - activating mode</p> <p>MAX - indicating MAX measured value</p> <p>MIN - indicating MIN measured value</p>	<p><b>MAIN SCREEN INDICATION</b></p> <p>MENU </p> <p>-2.9184</p> <p>0 </p> <p><b>MIN</b></p> <p>MENU </p> <p>7.2241</p> <p>0 </p> <p><b>MAX</b></p>
--	---	---

## FORMULA

<p><b>MENU SETTING</b></p> <p>⌂ Formula</p> <p>Formula: <math>Ax^2+Bx+C</math></p> <p>AX+BX+C</p> <p>Set Argv</p> <p>⌂ RESET</p>	<p><b>FORMULA <math>Ax^2+Bx+C</math></b></p> <p>A +000.000 Long push digit to select value</p> <p>B +001.000</p> <p>C +000.000</p> <p>Reset to zero arguments</p>	<p><b>EXAMPLE OF FORMULA USING</b></p> <p>Standard measuring A=0, B=1, C=0</p> <p>PRESET 50mm A=0, B=1, C=50</p> <p>Value magnification x3 A=0, B=3, C=0</p> <p>Square value A=1, B=0, C=0</p>
--	---	--

## TIMER

<p><b>MENU SETTING</b></p> <p>⌂ Timer</p> <p>+000 sec.</p> <p>RESET</p>	<p><b>Saving data to memory or sending Wireless by Timer</b></p> <p>Select timer period</p> <p>Reset to deactivate mode</p>	<p>⌂ Timer</p> <p>Confirm</p> <p>reset?</p> <p>Yes No</p>
---	---	---

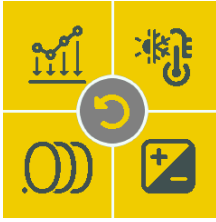

## MATHEMATICAL ERROR COMPENSATION

### MENU SETTING

Mathematical correction points with big error to normal values



Select all points

Add new point for error compensation



actual values

correct values by up&down button

confirm point correction

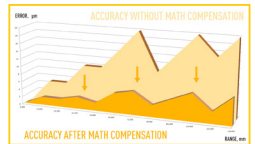

use gauge blocks or measuring machine for points correction

## TEMPERATURE COMPENSATION

### MENU SETTING

Re-calculation detail size to calibration conditions (20°C)

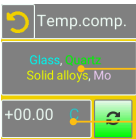

7 types of material for selection

Manual Temperature setting

7 types of material:

- glass, quartz, solid alloys
- granite, graphite
- Fe, Ni, Fe alloys
- stainless steel
- cooper, Cu alloys
- aluminium, al alloys
- acrylic sheet

## RESOLUTION

### MENU SETTING



Resolution selecting

mm/inch conversion

### MAIN SCREEN INDICATION

**+8.0608**

Selecting resolution of value on main screen and memory

## EXTRA (Axis mode)

### MENU SETTING

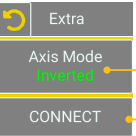

Selecting normal or inverted axis mode (+/- value indication)

Reading base reconnection for some types of calipers





## WIRELESS CONNECTION

**MENU SETTING** Activating or deactivating wireless data transfer

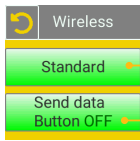

Switch on Wireless data transmission

Activating multifunctional button to save value to memory or send data by touchscreen or button push



## USB CONNECTION

**MENU SETTING** USB connection mode under construction

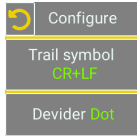
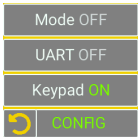

## PIN & RESET

**MENU SETTING** Activating PIN to device setting

RESET to factory settings

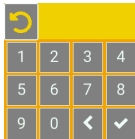
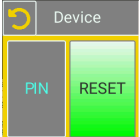

## DISPLAY SETTING

**MENU SETTING** DISPLAY ROTATION, BRIGHTNESS, SLEEPING MODE

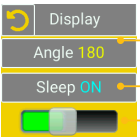

Display rotation 0°, 90°, 180°, 270°

- Sleep OFF (15 s low brightness off, sleep off)

- Sleep 15s (15 s low brightness on, sleep off)

- Sleep ON (15 s low brightness on, sleep on)

Brightness level

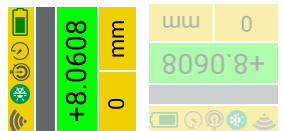



## MEMORY SETTINGS

MENU SETTING Activating or disactivating saving values to memory

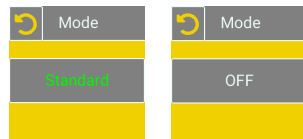

**Standard** - saving values to memory  
**OFF** - disable saving to memory

↻	☰	ALL
+7.3563		
-0.1109		
+1.2293		
+26.9993		
-8.8673		

## LINK TO SOFTWARE

MENU SETTING



QR Link to MICROTECH web site page with MDS Software download  
- Android, iOS, Windows versions  
- Free and Pro versions  
- Manuals



## CALIBRATION DATE

MENU SETTING Calibration date info

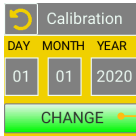

Push for change date info

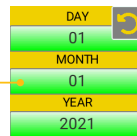

## DEVICE INFO

MENU SETTING



Information about device  
- device name  
- firmware version  
- MAC adress for easy connection

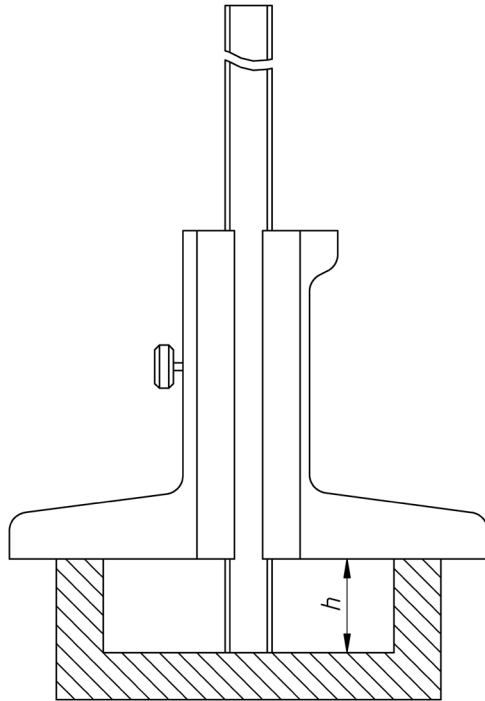



**MICROTECH**



**MICROTECH**

innovative measuring instruments

61001, Kharkiv, Ukraine, str. Rustaveli, 39

tel.: +38 (057) 739-03-50

[www.microtech.ua](http://www.microtech.ua)

[tool@microtech.ua](mailto:tool@microtech.ua)

Change without prior notice

Edition: M1030\_0520